

User Manual

Version V1.6-20231110



User Manual For Tersus GeoBee

Cost-effective Solution for CORS

©2019-2023 Tersus GNSS Inc. All rights reserved.



Sales Enquiry: sales@tersus-gnss.com

Technical Support: support@tersus-gnss.com

More details, please visit www.tersus-gnss.com

Revision History

Version	Revision Date	Change Summary
1.0	20190121	Initial Release
1.1	20190321	Update cover photo; Update section 2.1.2 Configure David; Add section 2.5 Observation Data Storage and 4.3 Check Link Status using Web Portal
1.2	20190712	Update photos of system structure and accessories; Update COMM1 cable and COMM2 cable; Update table 3 for David pin definition; Update mechanical drawing for AX3702.
1.3	20201210	Update section 2.1.2 commands to configure David; Update section 2.1.3 for TR600 configurations.
1.4	20210722	Add section 5
1.5	20211129	Add section 4.4 group user managing function and section 4.5 nearest base station.
1.6	20231110	Add User Agreement Update section 2.1.2

User Agreement

Copyright © 2019-2023 Tersus GNSS Inc.

CAUTION! Please read this notice carefully before using Tersus GeoBee. Use of GeoBee indicates acceptance of the terms and conditions of the User Agreement.

Thank you for using Tersus GeoBee! This agreement is a legally binding contract between Tersus GNSS Inc. and you regarding the user of GeoBee. Please read all the terms and conditions listed in the agreement carefully. Use of GeoBee indicates that you have agreed to accept all of the terms of this Agreement. If you have any questions about the content of the terms of this Agreement, please contact Tersus GNSS Inc. If you do not agree to any of the terms and conditions of this Agreement, please do not proceed with the subsequent operations.

1. License

Tersus provides users with free licenses for Tersus software and related materials, for the purpose of product needs and improvement, when users use Tersus products. Tersus does not guarantee that the free license will not be changed. The license fee will be calculated according to the price published on Tersus official website <http://www.tersus-gnss.com>. Before you pay the license fee as agreed, Tersus will reserve the right not to provide you with Tersus software and related materials. Without the permission of Tersus, users are not allowed to resell it to a third party or use Tersus software and related materials to obtain income through other means in any way.

2. Proprietary Rights

The user agrees that Tersus software and related materials shall belong to Tersus, and Tersus retains exclusive ownership of the trademarks and service marks represented by its company name and logo and all of the documentation related. The user agrees that all technologies, algorithms and

processes contained in Tersus software constitute commercial secrets, and the user will protect them. User may not reverse engineer, decompile or disassemble the software, nor alter images used in the software and the documentation. The user are not allowed to copy, modify, and reproduce relevant information, no matter it is modified or translated into another language, unless the permission of Tersus is obtained. The user agrees that if the user violates this agreement, he will be liable for damages determined by the court.

3.Customer Service

According to the situation of users using GeoBee, Tersus will continue to add features, improve performance and experience. Although it is the Tersus's customary practice to provide reasonable assistance and support in the use of Tersus products to customers, Tersus shall not be obligated to any user to provide technical assistance or support through this agreement, and may at Tersus's sole election charge a fee for customer service.

4.Update Policy

Tersus may regularly or irregularly, update the firmware of GeoBee to add functions or fix issues. Tersus is not obliged to provide updates or modifications to any user, nor do we guarantee that that updates or modifications are fully in line with expectations.

5.Disclaimer

Tersus will try best to make that the function of GeoBee run normally and the data calculation is correct, but Tersus does not guarantee that all functions of the GeoBee meets the expectations, the data calculation is correct and the stability of the GeoBee runs stably. Tersus and distributors will not be liable for any indirect, special, incidental, consequential or exemplary damages caused in any way.

6.Termination

This agreement is hereby terminated by mutual agreement or by any breach of

any one or more provisions of this agreement by either party. In such cases, all rights of Tersus shall remain in force and effect. Any protected information data of user maintained on database shall upon notice to the user and at the discretion of Tersus may be destroyed.

7. Copyright

Tersus GeoBee and related materials (including, but not limited to, any images, photographs, animations, video, audio, music or text incorporated into the GeoBee), and all intellectual property rights associated with it, whether exists in a tangible media or in an electronic media is owned by Tersus. You may not remove or alter any trademark, logo, copyright and other proprietary notice in or on the products.

8. Other

Tersus has the right to amend all the contents of this agreement and product policy, and the right to interpret them within the scope of law.

This agreement will be effective once it is published, and Tersus has the right to modify the content of the agreement at any time, and the modified results will be published on the Tersus website. If you do not agree with the modifications made, you have the right to stop using Tersus GeoBee. If the user continues to use, it is deemed that the user accepts the modifications.

The conclusion, implementation and interpretation of this agreement and the settlement of disputes shall be governed by the laws of China and subject to the jurisdiction of the Chinese courts. If any dispute arises between the parties regarding the content of this agreement or its implementation, the parties shall try to resolve it through friendly consultation, if consultation fails, either party may file a lawsuit in the court where Tersus GNSS is located.

Table of Content

Revision History	2
User Agreement	3
Table of Content	6
List of Figures	8
List of Tables	10
1. Introduction	11
1.1 Overview	11
1.2 System Structure	12
1.3 Devices in GeoBee Package	15
1.3.1 David GNSS Receiver	15
1.3.2 AX3702 GNSS Antenna	16
1.3.3 TR600 Ntrip Modem	17
1.3.4 Other accessories	18
1.4 Installation Guide	22
1.4.1 Install bottom plate for fixing David	22
1.4.2 Install bracket and slide rail for TR600	23
2. General Operation	24
2.1 Configurations	24
2.1.1 Accessories Required	24
2.1.2 Configure David	24
2.1.3 Configure TR600	28
2.2 Configuration Parameters	34
2.3 Factory Reset	35
2.4 Firmware Upgrade	35
2.5 Observation Data Storage	37
3. Specifications	40

3.1 David GNSS Receiver	40
3.2 AX3702 GNSS Antenna	43
3.3 TR600 Ntrip Modem	44
4. Typical Application	46
4.1 GeoBee working under Ntrip server mode	46
4.2 GeoBee working under Ntrip client mode	47
4.3 Check Link Status using Web portal	48
4.4 Group User Management Function	49
4.5 Nearest Base Station Function	53
5. Lightning-Proof Design	54
5.1 Direct lightning protection	54
5.2 Inductive lightning protection	55
5.2.1 Power lightning protection	55
5.2.2 Lightning protection for communication cables	55
5.2.3 Grounding net	56
6. Terminology	57

List of Figures

Figure 1.1 GeoBee System Structure	12
Figure 1.2 David GNSS Receiver	15
Figure 1.3 AX3702 GNSS Antenna	16
Figure 1.4 TNC-J to SMA Cable (GNSS antenna cable, 25m by default)	16
Figure 1.5 TR600 side view 1	17
Figure 1.6 TR600 side view 2	17
Figure 1.7 COMM1-Bluetooth Module	18
Figure 1.8 DC-2pin AC Power Adapter with 1.2m cable	18
Figure 1.9 COMM2-7pin to TR600-DC-2pin & DB9 female & USB cable	19
Figure 1.10 COMM1-7pin to DB9 male Cable	19
Figure 1.11 RS232 to RS485 converter	20
Figure 1.12 DB9 female to TR600-RS485-5pin cable	20
Figure 1.13 DB9 Female to USB Type A Male converter cable	20
Figure 1.14 USB Type A Female to USB (Micro +Type C) OTG cable ...	20
Figure 1.15 4G antenna for TR600	21
Figure 1.16 Wi-Fi antenna for TR600	21
Figure 1.17 Ethernet cable 1.5m	21
Figure 1.18 Bottom plate for fixing David	22
Figure 1.19 Dimension of bottom plate	22
Figure 1.20 TR600 dimension	23
Figure 1.21 Bracket for TR600	23
Figure 1.22 Slide rail for TR600 (20cm)	23
Figure 1.23 TR600 with bracket and slide rail	23
Figure 2.1 Configure David using Nuwa app	27
Figure 2.2 Properties for Internet Protocol (TCP/IP)	28
Figure 2.3 Set IP address as 'Obtain an IP address automatically'	28

Figure 2.4 Connect Ethernet cables	29
Figure 2.5 Login TR600 configuration interface	29
Figure 2.6 Check the current connection status	30
Figure 2.7 Select network in Network Settings	30
Figure 2.8 Mobile communication network settings	31
Figure 2.9 WAN setting	31
Figure 2.10 WiFi Client setting	32
Figure 2.11 LAN setting	32
Figure 2.12 Set Ntrip info in Ntrip configuration interface	33
Figure 2.13 Set Virhub configuration	34
Figure 2.14 Factory Reset for TR600	35
Figure 2.15 Update firmware for David	36
Figure 2.16 Update firmware for TR600	37
Figure 2.17 Launch STRSVR in RTKLIB	38
Figure 2.18 Input NTRIP Client information	38
Figure 2.19 Output information	38
Figure 2.20 Start saving observation data	39
Figure 3.1 Panel of David	42
Figure 3.2 Pin Definition of the COMM1/COMM2/DC ports	42
Figure 4.1 GeoBee under Ntrip server mode	46
Figure 4.2 GeoBee under Ntrip client mode	47

List of Tables

Table 1 Definition of LEDs	15
Table 2 David GNSS Performance	40
Table 3 Pin Definition of connectors on David	42
Table 4 AX3702 GNSS Antenna	43
Table 5 Ntrip Modem TR600 specifications	44

1. Introduction

This chapter mainly introduces the overview, system structure, package list, and installation guide of the Tersus GeoBee.

1.1 Overview

The Tersus GeoBee is a dedicated and cost-effective solution to establish a permanent reference station. With Tersus Ntrip Caster Service, Ntrip Modem and David Receiver, the GeoBee opens the possibility for users to transmit Real Time Kinematic (RTK) corrections via Internet (Ethernet or 2G/3G/4G) in a simple, user-friendly way, just using a SIM card or Ethernet cable without any need of a static IP. GeoBee can also work as GNSS Rover to receive RTK corrections from Tersus Ntrip Caster or any CORS service.

Ntrip server mode: use David GNSS receiver to create a base station. This temporary base or CORS are for surveying, agriculture, UAV, machine control, and etc. It is also ideal for deformation monitoring. Tersus GNSS Inc. provides Ntrip Caster to transfer data.

Ntrip client mode: connect David or other Tersus GNSS receivers to Tersus Ntrip Caster or any Ntrip/CORS service. David is mainly used for surveying, and also used as a GNSS sensor in various applications, such as mobile mapping, UAV, machine control, agriculture, and etc.

1.2 System Structure

Set up the GeoBee system according to the figure below.

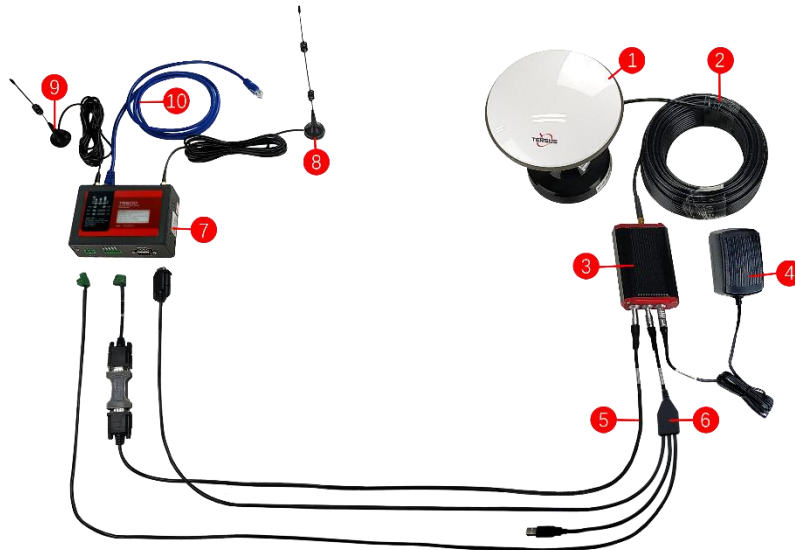

Figure 1.1 GeoBee System Structure

No.	Name
1	Antenna (AX3702 in the figure above, customizable)
2	TNC-J to SMA cable (25m by default, customizable)
3	David GNSS Receiver
4	Power Adapter (short for 'DC-2pin AC Power Adapter with 1.2m cable')
5	COMM1 cable (short for 'COMM1-7pin to DB9 male cable')
6	COMM2 cable (short for 'COMM2-7pin to TR600-DC-2pin & DB9 female & USB cable')
7	Ntrip Modem TR600
8	4G antenna for TR600
9	Wi-Fi antenna for TR600
10	Ethernet cable 1.5m

Note:

- 1) There are two configuration modes for GeoBee. GeoBee system is configure-free if customer adopts GeoCaster provided by Tersus GNSS Inc., as GeoBee is pre-configured when shipped out of factory. GeoBee system needs to be configured if customers demand to set up caster by themselves.
- 2) David GNSS receiver uploads RTCM stream to the NTRIP caster using Ethernet (default) or Wi-Fi or 2G/3G/4G sorted by priority. For Ntrip Modem TR600, Wi-Fi client and Wi-Fi hotspot are both supported, however they cannot be enabled simultaneously. Wi-Fi client function is to use Wi-Fi connection to communicate with caster. Wi-Fi hotspot function is to share internet connection to other devices.
- 3) Place the antenna (AX3702 in the Figure 1.1) in the outdoor open environment. Install Wi-Fi antenna when Wi-Fi connection is available for communication. Install 4G antenna when 2G/3G/4G SIM card is used for communication.
- 4) GeoBee starts to work in auto start mode by default once it is powered up. According to the autonomous positioning (without RTK or DGPS), it smooth out the average value to be the base coordinate. GeoBee outputs the RTCM32 corrections data and sends to the Ntrip caster through LAN, WIFI or 2G/3G/4G mobile network.
- 5) For the known phase center coordinates of the AX3702 antenna, the two configuration methods are as follows:
 - a. Use the 'DB9 Female to USB Type A Male converter cable' to connect the COMM1 cable in Figure 1.1 and a computer, open Tersus GNSS Center application on the computer, and type below commands in the command window:

```
POSAVE OFF           //Turn off position average
UNDULATION USER 0.0  //Set user specified undulation value for ellipsoid height1
FIX POSITION B L H     // B: latitude (degree), L: longitude (degree), H: height (m)
                    For example: FIX POSITION 31.24523012 121.58922341 40.35
SAVECONFIG           //save configuration
```

Note 1: If customer needs to use global geoidal height model EGM96 for mean sea level height, type below command to replace the undulation command above.

UNDULATION EGM96**//Set EGM96 geoidal height model**

More details about logs and commands refer to *Log & Command Reference* document.

- b. Use the COMM1-Bluetooth module in the package, insert the Bluetooth module to the COMM1 port of David GNSS receiver. Launch Nuwa app on an android device, connect David by pairing Bluetooth. Create a base configuration with manual start in radio mode, fill in the base coordinates and antenna height, and set Baud Rate as 115200 bps and Differential Format as RTCM3.2. Detailed operation refers to *User Manual for David GNSS Receiver*.
- 6) The known phase center coordinates of the AX3702 antenna can be obtained from surveying and mapping department of local government, or calculated from commercial software such as Bernese or Gamit.

1.3 Devices in GeoBee Package

1.3.1 David GNSS Receiver

David has four interfaces which is shown below.



Figure 1.2 David GNSS Receiver

The DC port of David is for power input, COMM1 port is for COM1 and CAN ports, and COMM2 port is for COM2 and USB ports, refer to section 3.1 for detailed specification of David.

Table 1 Definition of LEDs

LED	Colour	Description
PWR	RED	ON: the David is power on.
PV	BLUE	ON: David in Fixed solution.
		Blink: David in Float solution
		OFF: David in other position types.

1.3.2 AX3702 GNSS Antenna

AX3702 GNSS antenna is used to receive the RF signal from the satellites, and it must be connected to the David with the GNSS antenna cable in the package.



Figure 1.3 AX3702 GNSS Antenna



If an antenna from other companies is used, contact Tersus to obtain permission, or the David receiver may not work as expected.



Figure 1.4 TNC-J to SMA Cable (GNSS antenna cable, 25m by default)

1.3.3 TR600 Ntrip Modem



Figure 1.5 TR600 side view 1

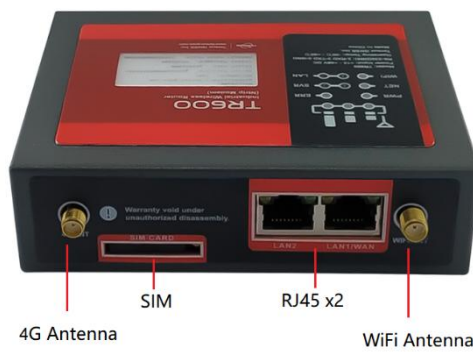

Figure 1.6 TR600 side view 2

1.3.4 Other accessories



Figure 1.7 COMM1-Bluetooth Module



The Bluetooth can only be installed to the COMM1 port of David.

This Bluetooth module is used to connect to the COMM1 port of David receiver.

The SSID of this Bluetooth module is BT420R-xxxxx_xxxxxx, where the first xxxxx is the last 5 digits of the Bluetooth serial number, which is printed on the Bluetooth module. No password is needed to pair with it.



Figure 1.8 DC-2pin AC Power Adapter with 1.2m cable



Figure 1.9 COMM2-7pin to TR600-DC-2pin & DB9 female & USB cable

!	The circular connector of the COMM2-7pin to TR600-DC-2pin & DB9 female & USB cable can only be installed into the COMM2 port of David GNSS Receiver.
---	--

The COMM2-7pin to TR600-DC-2pin & DB9 female & USB cable has two functions:

- 1) Connect to DB9 female to USB Type A Male converter cable (refer to Figure 1.13) to download the file saved on the internal eMMC, refer to section *Download Files from Internal eMMC* in David user manual;
- 2) Connect to USB Type A Female to USB (Micro +Type C) OTG cable (refer to Figure 1.14) to connect the Android phone or controller with David.



Figure 1.10 COMM1-7pin to DB9 male Cable

!	The circular connector of the COMM1-7pin to DB9 male cable can only be installed into the COMM1 port of David GNSS Receiver.
---	--



Figure 1.11 RS232 to RS485 converter



Figure 1.12 DB9 female to TR600-RS485-5pin cable



Figure 1.13 DB9 Female to USB Type A Male converter cable



Figure 1.14 USB Type A Female to USB (Micro +Type C) OTG cable



Figure 1.15 4G antenna for TR600



Figure 1.16 Wi-Fi antenna for TR600



Figure 1.17 Ethernet cable 1.5m

1.4 Installation Guide

1.4.1 Install bottom plate for fixing David



Figure 1.18 Bottom plate for fixing David

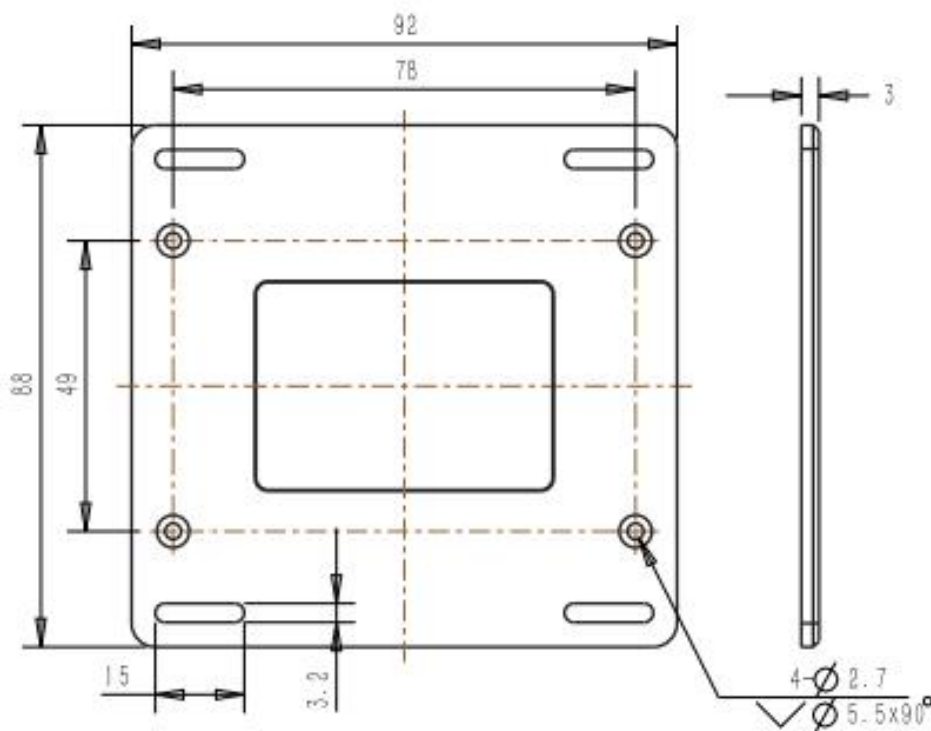

Figure 1.19 Dimension of bottom plate

Use the screws in the package to secure the bottom plate to the back of the David GNSS receiver. Hence it can be fixed to the places required.

1.4.2 Install bracket and slide rail for TR600

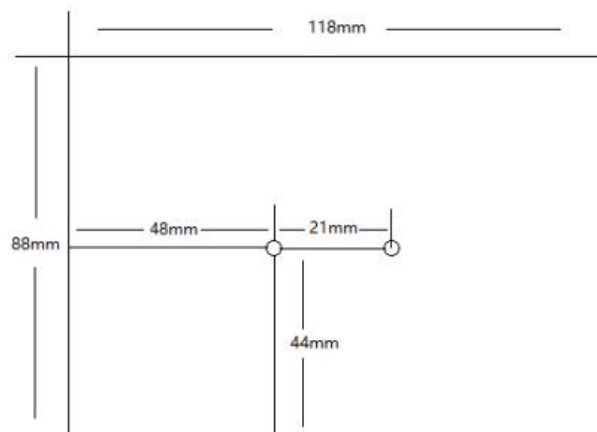

Figure 1.20 TR600 dimension

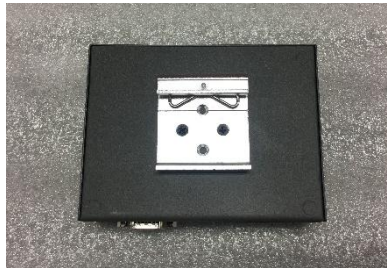

Figure 1.21 Bracket for TR600



Figure 1.22 Slide rail for TR600 (20cm)



Figure 1.23 TR600 with bracket and slide rail

Fix the bracket to the back of the TR600 with two screws, slide the rail into the bracket, and then use screws to fix the whole set to the places required.

2. General Operation

This chapter introduces how to use GeoBee, configuration parameters, factory reset and firmware upgrade.

2.1 Configurations

2.1.1 Accessories Required

The accessories required are listed below:

- 1) One Power Adapter (DC-2pin AC Power Adapter with 1.2m cable);
- 2) One COMM1 cable (COMM1-7pin to DB9 male cable);
- 3) One DB9 Female to USB Type A Male Converter cable;
- 4) One COMM1-Bluetooth module;
- 5) One Ethernet cable for connecting TR600 and PC or customized device.

2.1.2 Configure David

Configuring David is able to be done using Tersus GNSS Center via cables or using Nuwa app via Bluetooth.

The detailed steps of configuring David using Tersus GNSS Center via cables are listed below:

- 1) Use the 'DB9 Female to USB Type A Male Converter cable' to connect the COMM1 cable (COMM1-7pin to DB9 male cable) and a computer;
- 2) Open Tersus GNSS Center application on the computer and type below commands in the command window:

```
POSAVE OFF //Turn off position average2
UNDULATION USER 0.0 //Set user specified undulation value for ellipsoid height3
FIX POSITION B L H //B: latitude (degree), L: longitude (degree), H: height (m)
For example: FIX POSITION 31.24523012 121.58922341 40.35
or POSAVE ON 0.02 //Turn on position average for 0.02 hour (72s)
LOG COM2 RTCM1074 ONTIME 1 //output GPS RTK raw measurements
LOG COM2 RTCM1084 ONTIME 1 //output GLONASS raw measurements
LOG COM2 RTCM1124 ONTIME 1 //output BeiDou RTK raw measurements
LOG COM2 RTCM1005 ONTIME 10 //output the base's position
LOG COM2 RTCM1230 ONTIME 5 //output GLONASS bias information
SAVECONFIG //save configuration
```

Note 2: By default, GeoBee is set to base mode with the command POSAVE ON. If you want to use the command FIX POSITION B L H to enter the coordinate of a known point, you must first enter POSAVE OFF to turn off position averaging. Otherwise, during the next power cycle, the position average will be turned on, which can cause a change in the base coordinate.

Note 3: If customer needs to use global geoidal height model EGM96 for mean sea level height, type below command to replace the undulation command above.

```
UNDULATION EGM96 //Set EGM96 geoidal height model
```

More details about logs and commands refer to *Log & Command Reference* document.

3) Power cycle the receiver or input RESET command to make the above configuration effective.

The detailed steps of configuring David via Bluetooth are listed below:

- 1) Insert the 'COMM1-Bluetooth module' into the COMM1 port of David GNSS receiver;
- 2) Connect the AX3702 GNSS antenna to David with the GNSS antenna cable;
- 3) Power on the David GNSS receiver by plugging the AC power adapter;
- 4) Run Nuwa app, click [Device] -> [Connect];
- 5) Select [David] in the option list of Device Type;
- 6) Select [Bluetooth] in the option list of Connect Type;
- 7) Click [Connect Config] -> [Search]. The SSID is BT420R-xxxxx_xxxxxx. No password is needed to pair with it;
- 8) Click [Connect] to enable the communication with David;
- 9) After the Bluetooth module is connected with David successfully, configure David as a base with manual start in radio mode, fill in the base coordinates and antenna height, and set Baud Rate as 115200 bps and Differential Format as RTCM3.2. Detailed operation about David and Nuwa app refers to the *User Manual for David GNSS Receiver* and *User Manual for Nuwa app* which can be downloaded on Tersus website.

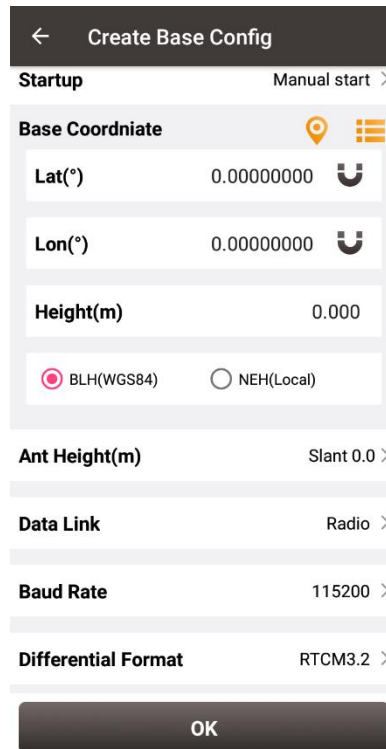

Figure 2.1 Configure David using Nuwa app

!	A Bluetooth device can be removed from the Available Device list by pressing it for a few seconds.
---	--

2.1.3 Configure TR600

The detailed steps of configuring TR600 are listed below:

- 1) Set IP address of the PC as 'Automatically obtain IP address';

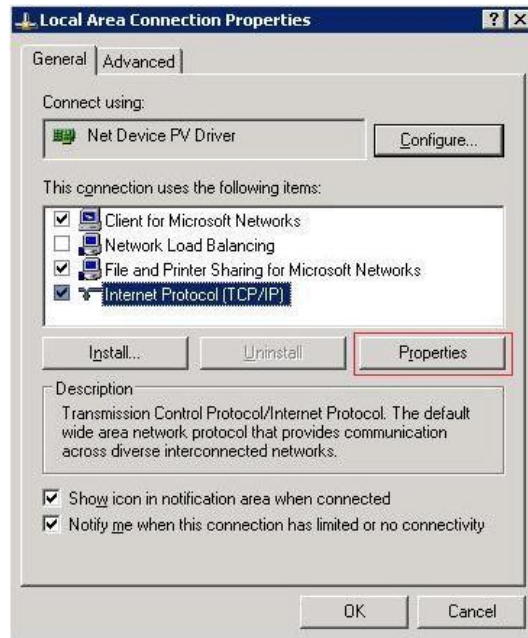

Figure 2.2 Properties for Internet Protocol (TCP/IP)

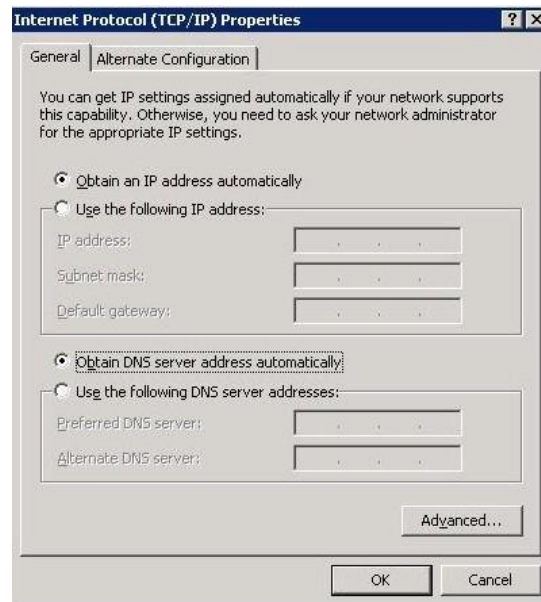

Figure 2.3 Set IP address as 'Obtain an IP address automatically'

- 2) Using Ethernet cable to connect the LAN1/WAN port to a router to access Internet, connect the LAN2 port of TR600 to your PC;



Figure 2.4 Connect Ethernet cables

- 3) Type in 192.168.100.1 or 192.168.1.1 in the browser of PC to enter the web configuration login page;
- 4) Type in username 'root' and password '1234' in the login page;

TR-600	
用户名 (username):	<input style="width: 100%;" type="text"/>
用户密码 (passwd):	<input style="width: 100%;" type="password"/>
语言 (language):	ENGLISH ▾
<input type="button" value="登陆(login)"/>	

天硕导航

Figure 2.5 Login TR600 configuration interface

- 5) In the web configuration interface, check the current connection status.

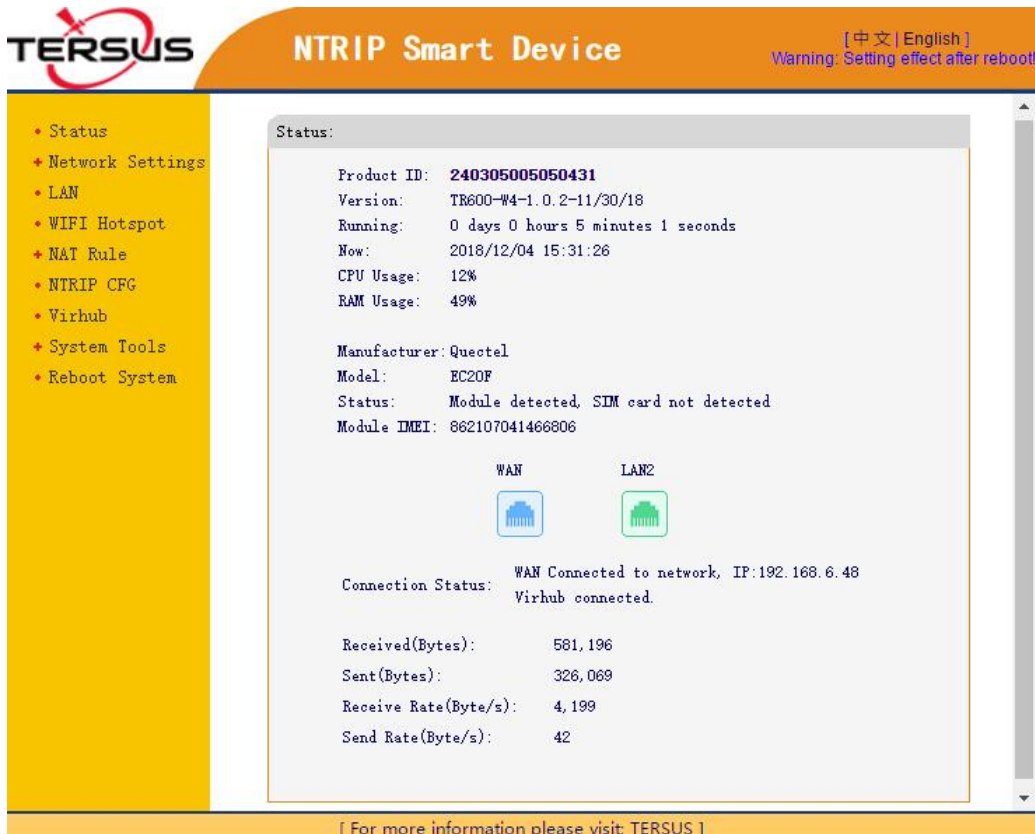

Figure 2.6 Check the current connection status

- 6) Select 'WAN&WIFI&MOBILE' for Network option in Network Settings, and click [Save] to save this setting.

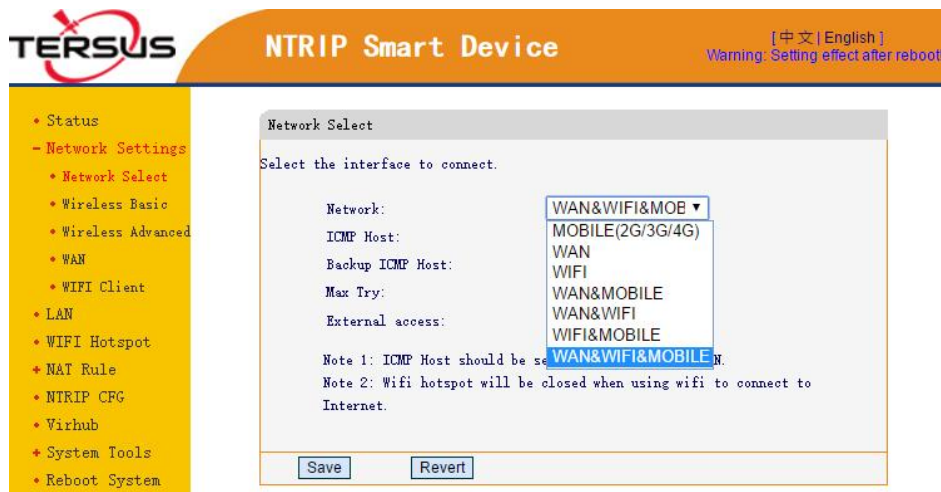

Figure 2.7 Select network in Network Settings

- 7) For Wireless Basic, it is to configure 2G/3G/4G network parameters. Consult your local mobile carrier for the APN settings. Below screenshot is taking Telstra from Australia for example, Telstra.wap is auto selected as the APN. The APN mode can also be manually selected, prepare your local

APN info and fill in manually.

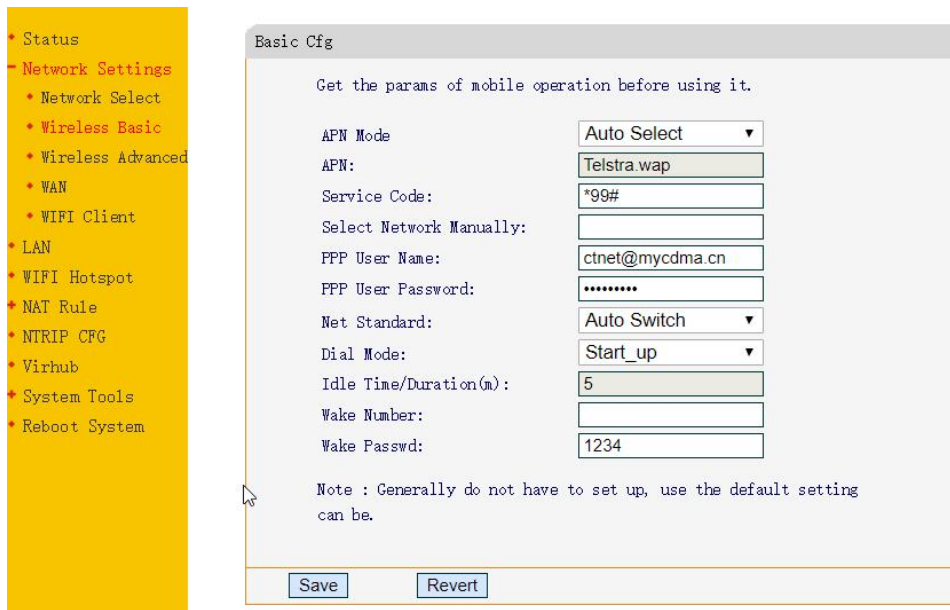

Figure 2.8 Mobile communication network settings

- 8) For the WAN setting, use the default DHCP as most routers support DHCP. The WAN is connected to your router’s LAN, then the router will assign an IP address to the TR600 modem.

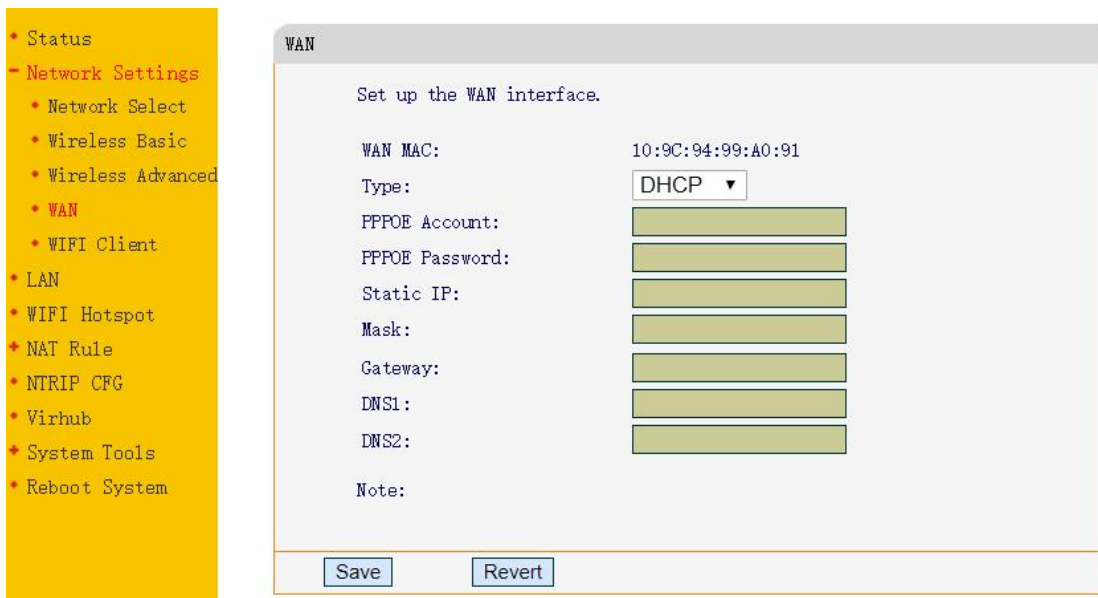

Figure 2.9 WAN setting

- 9) If WIFI Client is chosen to access internet, click WIFI Client in Network Settings, select a SSID to be used and type in the WIFI password in the PSK pin area, click [Save] to save this setting.

WIFI Client

This Page: Set WIFI parameters

WIFI MAC: 28:AD:3E:4E:0D:63

SSID: wellcores_tp

Security: WPA2-PSK AES

PSK pin:

Type: DHCP

Static IP:

Mask:

Gateway:

DNS1:

DNS2:

Save Revert

WIFI AP list Refresh

Note: If wifi is disabled, the first time clicking "Refresh", it need some time to output the result.

	SSID	Signal (0-100)	Security
	X360-1030545	23	[WPA2]
	12345679	64	[WPA2]
	fu	62	[WPA2]
	11352937	36	[WPA2]
	GNSS-1032686	23	[WPA2]
	heloskin	38	[WPA2]
	ChinaNet-0xq8	23	[WPA2]
	wellcores_tp	23	[WPA2]
	wellcores_tp	23	[WPA2]
	Heloskin	26	[ESS]

[For more information please visit TERSUS]

Figure 2.10 WiFi Client setting

10) For LAN setting, the LAN configuration is obtained automatically when the TR600 modem is connected to the router.

LAN

Set up the router IP of LAN and set the DHCP function.

Gateway IP: 192.168.2.1

Mask: 255.255.255.0

DHCP Start IP: 192.168.2.20

DHCP End IP: 192.168.2.254

DNS IP:

DHCP Lease: 86400 Lease: (1~200000)

DHCP Service: ON

Note : Gateway IP and DHCP Settings must be in the same network.

Save Revert

Figure 2.11 LAN setting

11) Set corresponding NTRIP information in NTRIP configuration interface as shown in the upper red box according to the NTRIP information attached as a label on the Ntrip Modem TR600. The information for Data Center 1 in the lower red box is pre-configured as default if Tersus mserver is used. Contact Tersus Technical Support if users need other server for Data Center.

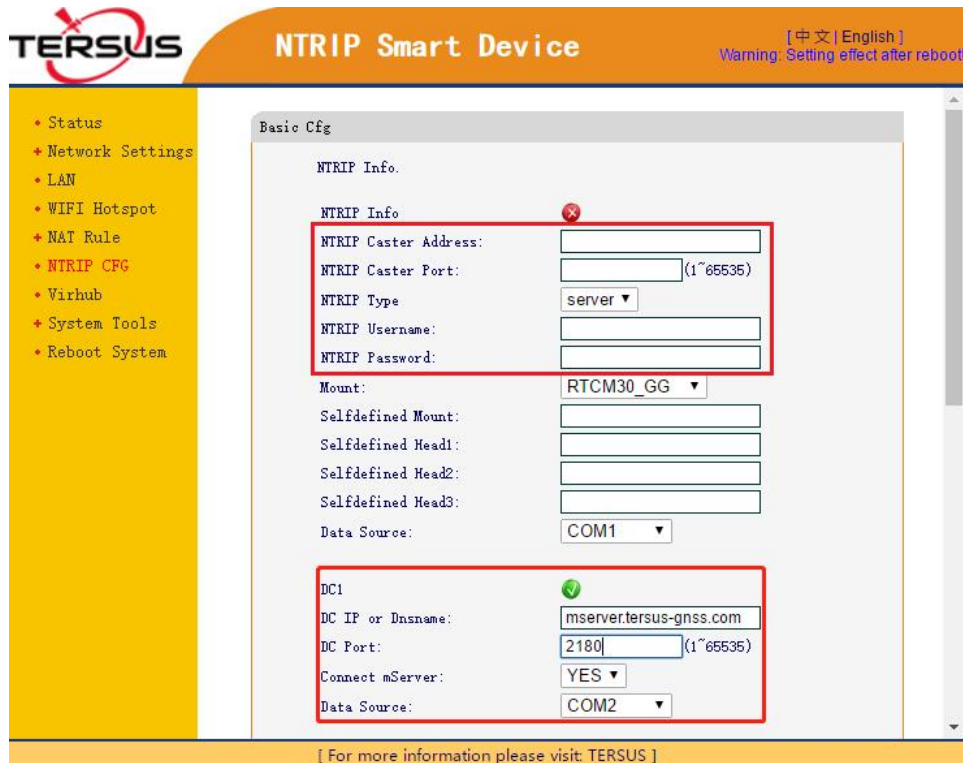

Figure 2.12 Set Ntrip info in Ntrip configuration interface

12) Turn on the virtual hub function and configure Virhub according to the information which is shown below. It is pre-configured as default. Contact Tersus Technical Support if users need other server for the Virhub configuration.

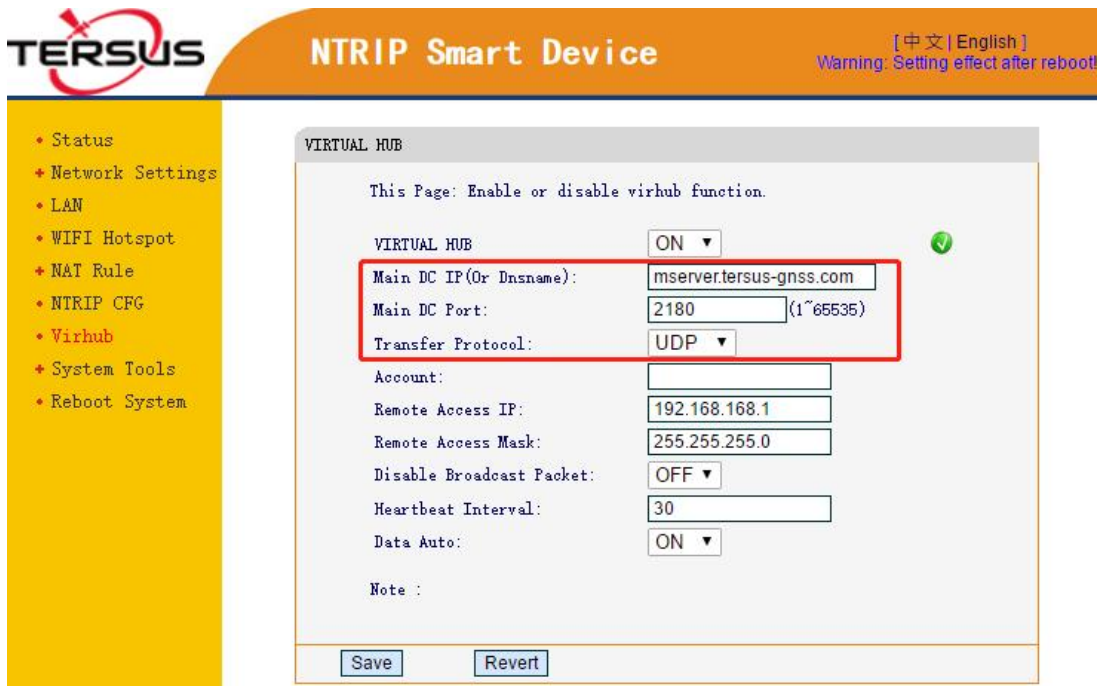

Figure 2.13 Set Virhub configuration

13) After setting the above configurations, click [Save] and reboot the device to active the configuration. The configuration becomes effective only after the Ntrip Modem TR600 is restarted.

Note: the mserver software and Verhub software are under development, stay tuned.

2.2 Configuration Parameters

The configuration menu of David GNSS receiver can be viewed on Nuwa app, the detailed usage of Nuwa app refers to the user manual of Nuwa app which can be downloaded on Tersus official website

<https://www.tersus-gnss.com/document/david-receiver>

under the User Manual section.

Each configuration menu of Ntrip Modem TR600 has multiple parameters, and some of them have sub-menus. The detailed configuration parameters refer to section 2.2 of the user manual of Ntrip Modem TR600.

2.3 Factory Reset

The factory reset of David GNSS receiver can be completed on Nuwa app by clicking [Reset] on the Device Info interface. The detailed usage of Nuwa app refers to the user manual of Nuwa app which can be downloaded on Tersus official website <https://www.tersus-gnss.com/document/david-receiver> under the User Manual section.

In the TR600 configuration interface, select 'Restore Set' under 'System Tools', click [Restore Set] to reset to factory settings; or long press the RESET button to reset.

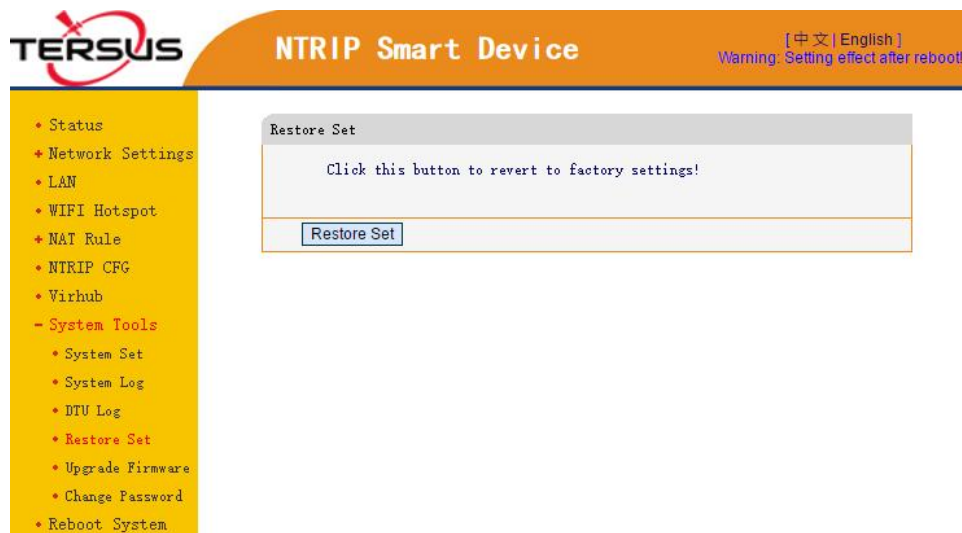

Figure 2.14 Factory Reset for TR600

2.4 Firmware Upgrade

The updated firmware is released and available for downloading on Tersus

web site <https://www.tersus-gnss.com/software> , or it can be obtained from Tersus technical support. After completing the hardware connection mentioned in 2.1.2 Configure David, launch the TersusUpdate software on the desktop or click [Tools] -> [UpdateFirmware] in Tersus GNSS Center software.

In the TersusUpdate interface, the software recognizes the serial port and scans the baud rate automatically. Select the Port which is connected to David receiver, browse the location for the updated firmware file, and click [Next] to update the firmware.

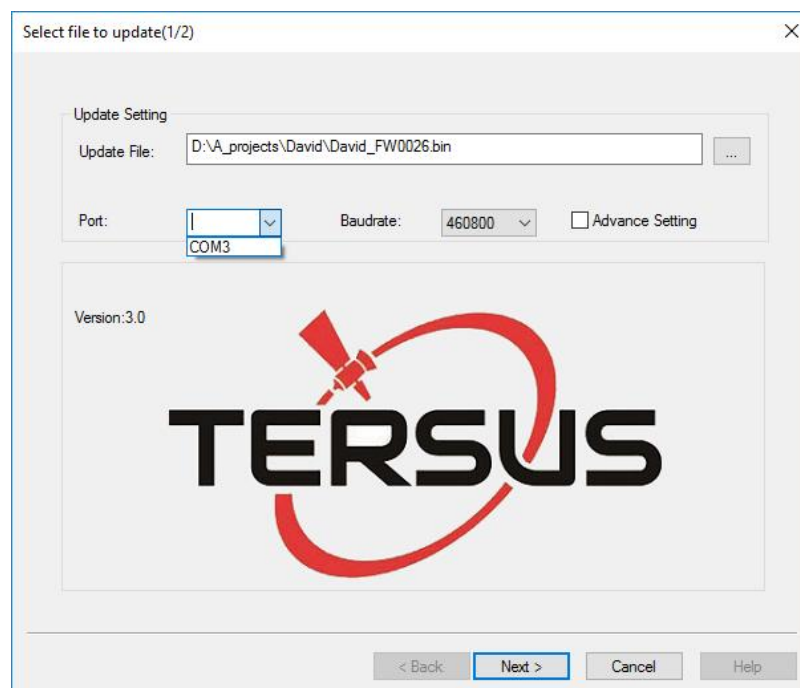

Figure 2.15 Update firmware for David

Contact Tersus Support for firmware file to upgrade Ntrip Modem TR600. Select 'Upgrade Firmware' under 'System Tools' in the TR600 configuration interface, choose the firmware file, and click [Upload/Download] to upload the firmware.



Figure 2.16 Update firmware for TR600

Wait for a few minutes until 'Update' is shown, choose 'Delete the former file'. Click [Update], it will prompt that the file system has been updated, the original setting is cleared, and the system is rebooting.

2.5 Observation Data Storage

Since it is not supported to download observation data remotely, it is recommended using RTKLIB, an open source program for GNSS positioning, to store the observation data as a file in the computer.

The detailed steps of how to store observation data into a computer are as follows:

- 1) Download RTKLIB software from its official website <http://www.rtklib.com/> , unzip the zip file and find the application rtklaunch.exe
- 2) Double click rtklaunch.exe and then click the third icon to launch STRSVR function.



Figure 2.17 Launch STRSVR in RTKLIB

- 3) In the STRSVR interface, select 'NTRIP Client' as input type, click the Opt button on the right, fill all the information for NTRIP Client Options and then click [OK].

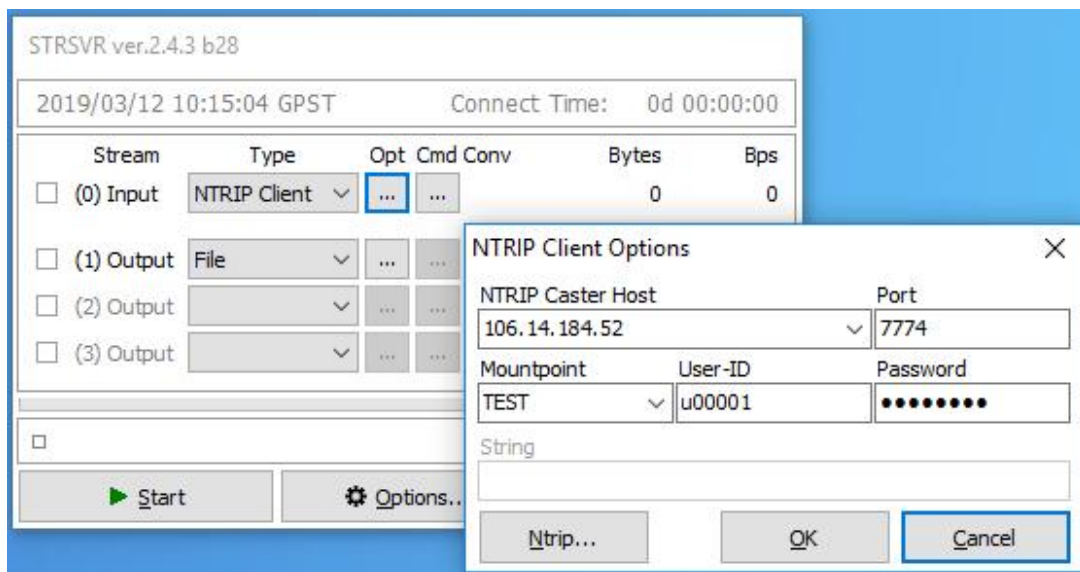

Figure 2.18 Input NTRIP Client information

- 4) Select 'File' as output type, click the Opt button on the right, browse a location for the Output File Path, and click [OK].

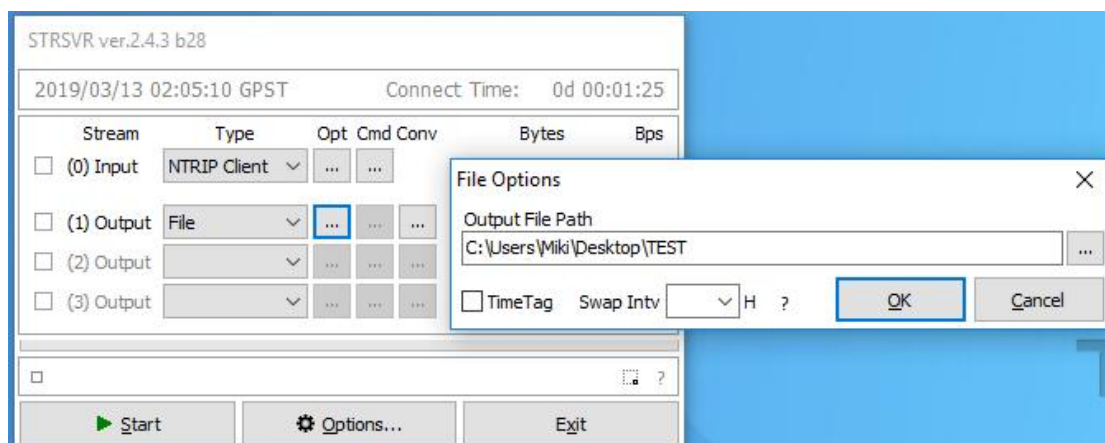

Figure 2.19 Output information

- 5) Go back to the main page, and click [Start]. The observation data will be

stored in file of the designated folder. The file is being saved as shown below.

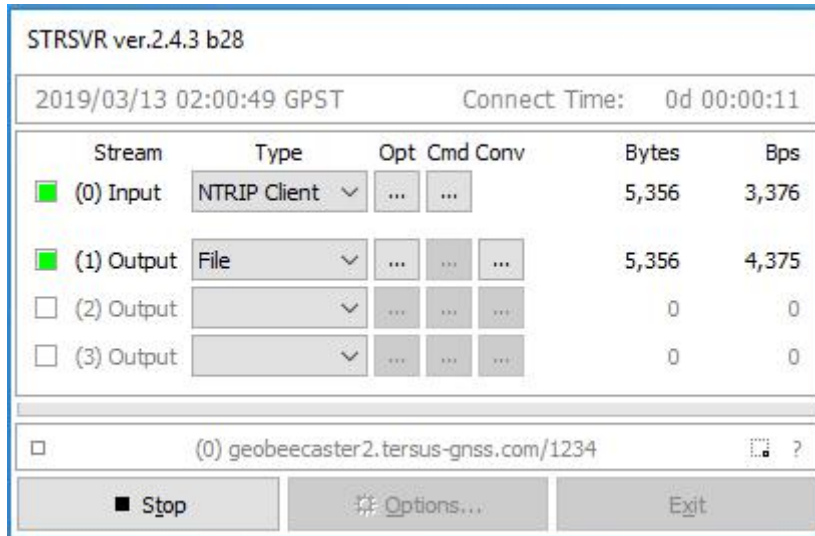

Figure 2.20 Start saving observation data

3. Specifications

This chapter includes the specifications of David GNSS Receiver, AX3702 GNSS Antenna and TR600 Ntrip Modem.

3.1 David GNSS Receiver

Table 2 David GNSS Performance

GNSS Performance		
Signal tracking	GPS L1, L2; GLONASS L1, L2; BeiDou B1, B2	
GNSS channels	384	
Position Accuracy	Single positioning	1.5m RMS (Horizontal)
		3.0m RMS (Vertical)
	RTK Positioning	10mm+1ppm (Horizontal)
		15mm+1ppm (Vertical)
	Static post processing	3mm+0.5ppm (Horizontal)
		5mm+0.5ppm (Vertical)
Time to First Fix	Cold Start: <50s Warm Start: <30s	
Reacquisition	0.5s L1 (typical) 1.0s L2 (typical)	
Data Rate	Measurements	20Hz
	Position	5Hz
Time Accuracy	20ns RMS	
Velocity Accuracy	0.03m/s RMS	
Measurement Precision	C/A Code	10cm
	P Code(zenith direction)	10cm
	Carrier Phase (zenith direction)	1mm
Physical Description		

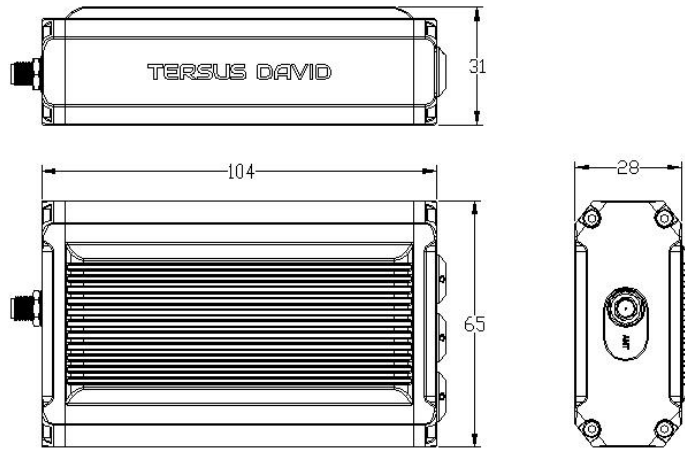
Dimension	104*65*31 mm (David only)
Weight	250g (David only)
Mechanical Drawing	
	
Environmental	
Operating Temperature	-40°C to +85°C
Storage Temperature	-55°C to +95°C
Humidity	MIL-STD-810G, Method 507.5 Procedure II (95%)
Random Vibration	MIL-STD 810G Method 514.6, Category 24 (7.7 g RMS)
Sinusoidal Vibration	IEC 60068-2-6 (5 g)
Bump	ISO 9022-31-06 (25 g)
Shock	Operating: MIL-STD-810G, Method 516.6, Procedure I (40 g) Non-operating: MIL-STD-810G, Method 516.6, Procedure V (75 g)
Water & dust proof	IP67
Power Requirement	
Input Voltage	+5 ~ 12 VDC
Power Consumption	3.2W without external Radio 9.8W with external 2W radio

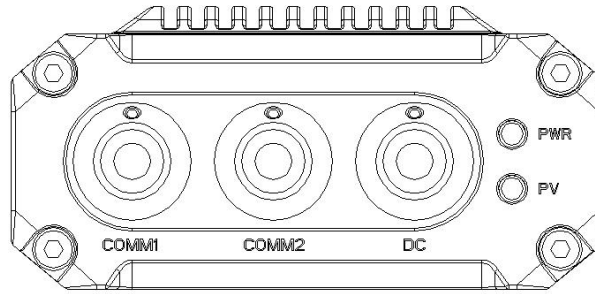

Figure 3.1 Panel of David

Table 3 Pin Definition of connectors on David

Connector Pin No.	COMM1 RS-232	COMM2 RS-232	DC
1	PWR	PWR	PWR
2	GND	GND	GND
3	TXD1	TXD2	
4	RXD1	RXD2	
5	GND	GND	
6	NC	USB D+	
7	NC	USB D-	

The pin definition's view from outside to David is as below.

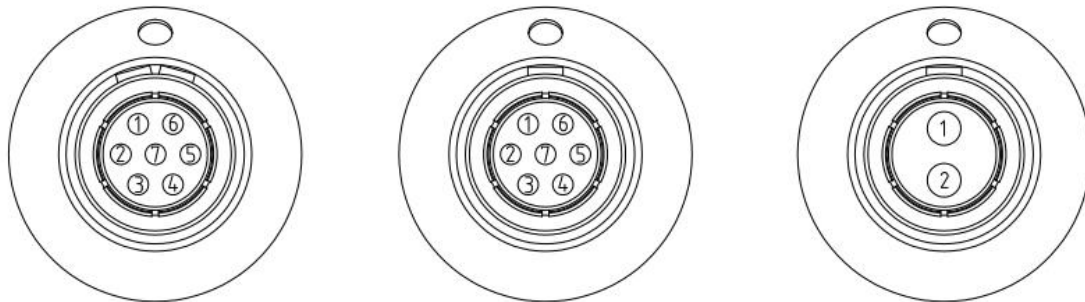
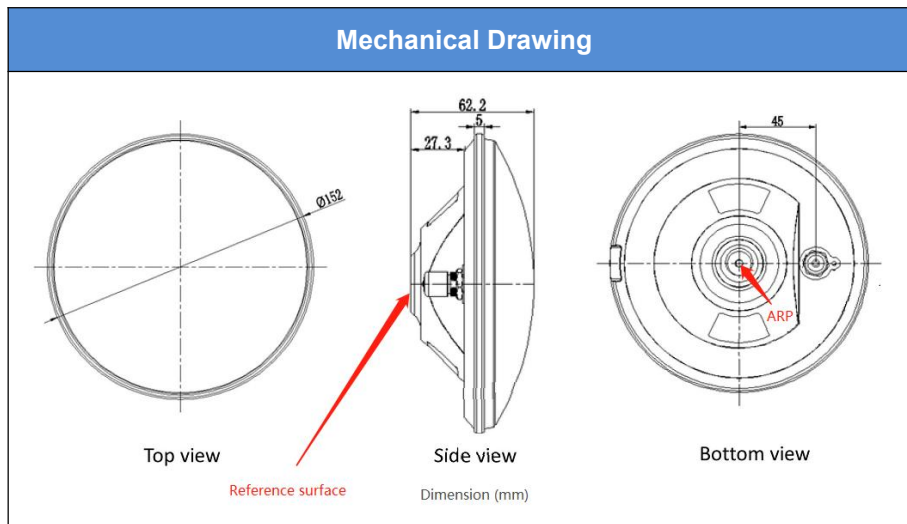

Figure 3.2 Pin Definition of the COMM1/COMM2/DC ports

3.2 AX3702 GNSS Antenna

Table 4 AX3702 GNSS Antenna

Antenna Specification	
Tracking signals	GPS L1/L2/L5; BDS B1/B2/B3; GLONASS L1/L2
Impedance	50 Ohm
Polarization	RHCP
Axial Ratio	≤ 3dB
Azimuth Coverage	360°
Output VSWR	≤ 2.0
Peak Gain	5.5dBi
Phase Center Error	± 2mm
LNA Specification	
LNA Gain	40±2dB
Noise Figure	≤ 2.0dB
VSWR	≤ 2.0
Input Voltage	3.3~12V DC
Operating Current	≤ 45mA
Ripple	± 2dB
Physical Description	
Dimension	Φ152*62.2mm
Weight	374g
Signal Connector	TNC Female
Installation connector	5/8" x 11
Environmental	
Operating temperature	-45°C - +85°C
Storage temperature	-45°C - +85°C
Damp	45% - 95%



3.3 TR600 Ntrip Modem

Table 5 Ntrip Modem TR600 specifications

Electrical	
Input Voltage	+12 ~ +48V DC
Operating Current	350mA @ +12V DC
Standby Current	250mA @ +12V DC
Power Consumption	4.2W (typical)
Network	
Chinese version	2G: GSM/GPRS/EDGE/CDMA2000 1x 3G: UMTS/WCDMA/HDSPA/HSPA+/TD-SCDMA/CDMA2000 EVDO 4G: TDD-LTE/FDD-LTE
Eurasian version (Europe, Middle East, Africa, South Korea, Thailand)	2G: GSM/GPRS/EDGE 3G: UMTS/WCDMA/HDSPA/HSPA+ 4G: TDD-LTE/FDD-LTE
North American version	3G: UMTS/WCDMA/HDSPA/HSPA+ 4G: FDD-LTE
Australian version (New Zealand, Australia, South	2G: GSM 3G: WCDMA

America)	4G: FDD-LTE/TDD-LTE
Operating Frequency Band	
Chinese version	TDD-LTE B38/B39/B40/B41 FDD-LTE B1/B3/B8 UMTS/HSDPA/HSPA+ B1/B8 TD-SCDMA B34/B39 CDMA2000 1x/EVDO BC0 GSM/GPRS/EDGE 900/1800 MHz
Eurasian version	TDD-LTE B38/B40 FDD-LTE B1/B3/B7/B8/B20 UMTS/HSDPA/HSPA+ B1/B8 GSM/GPRS/EDGE 900/1800 MHz
North American version	FDD-LTE B2/B4/B5/B17 UMTS/HSDPA/HSPA+ B2/B5
Australian version	FDD-LTE B1/B2/B3/B4/B5/B7/B8/B28 TDD-LTE B40 WCDMA B1/B2/B5/B8 GSM 850/900/1800/1900
Interfaces	
Serial Port	RS232 x1, RS485 x1
Ethernet	RJ45 x2 (LAN, LAN/WAN)
Antenna Connector	SMA Female x1
Physical	
Dimension	118x91x34mm (w/o connectors)
Weight	335g
Operating Temperature	-30°C ~ +80°C
Relative Humidity	95% @ +40°C

4. Typical Application

Typically, GeoBee can work under both Ntrip server mode and Ntrip client mode. The system structure for them is the same, the configuration of Ntrip Modem TR600 is different.

4.1 GeoBee working under Ntrip server mode

If GeoBee is configured to work under Ntrip server mode, fill in the Ntrip information under the [NTRIP CFG] sub menu. Select [server] in the drop-down menu of Ntrip Type, type in the Ntrip password and click [Save] at the bottom of this page to complete the configuration.

The Ntrip information can be found on Ntrip Modem TR600. If there is any question, please contact Tersus Technical Support by email support@tersus-gnss.com without any hesitate.



Figure 4.1 GeoBee under Ntrip server mode

4.2 GeoBee working under Ntrip client mode

If GeoBee is configured to work under Ntrip client mode, fill in the Ntrip information under the [NTRIP CFG] sub menu. Select [client] in the drop-down menu of Ntrip Type, type in the Ntrip Username and Ntrip password, and click [Save] at the bottom of this page to complete the configuration.

The Ntrip information can be found on Ntrip Modem TR600. If there is any question, please contact Tersus Technical Support by email support@tersus-gnss.com without any hesitate.



Figure 4.2 GeoBee under Ntrip client mode

4.3 Check Link Status using Web portal

Open any browser on your computer (accessible to the Internet) and enter the following URL in the address bar: <http://geobeeaster2.tersus-gnss.com:2101/>
 In the login window, type the (Ntrip) Client User and (Ntrip) Client Password which are shown on the label of the Ntrip Modem TR600.

```
NtripName:
geobeeaster2.tersus-gnss.com
NtripPort: 2101
Client User: geobeetest1
Client Password: s65uhkJd
Default Mount Point: 240305085154981
```

Figure 4.3 the login window

After a successful login, the link status and statistics are shown in the figure below:

Current Time:19-03-19 03:56:19(-0000)

Server/Client Current Status

S/C	From IP	MountPoint	StartTime	Data Bytes(KB)	Data Type	lat/long/ellipsoid height
Server	221.178.124.152	2403050050	19-03-19 02:02:35(-0000)	2896.824	RTCM3	594690/107.883409/107.4092

Statistics

MountPoint	First Start Time	PAS Count/ideal	total online rate(%)	Error/Valid Package	lat/long/ellipsoid height
2403050050	18-12-13 02:52:14(-0000)	2569/4610	55.74	0/15265991	594690/107.883409/107.4092

240305005050828 Hourly online rate from 03/17 to 03/19(-0000)

	00	01	02	03	04	05	06	07	08	09	10	11	12	13	14	15	16	17	18	19	20	21	22	23
03/17	100	100	99	100	100	97	97	98	99	100	97	100	99	100	100	100	100	100	100	100	100	100	100	100
03/18	100	100	100	100	100	100	100	99	100	100	100	100	100	100	100	100	100	100	100	100	100	100	100	100
03/19	100	100	99	93																				

Figure 4.4 the link status and statistics

4.4 Group User Management Function

The Group User function is mainly used for regional agent to manage and configure Client end-users with different privileges after using GeoBee builds a certain number of base stations in a region.

Specifically, under previous versions of Caster software, after the regional agent sends data from the GeoBee base station (NtripServer) in the region to the Caster software (NtripCaster) using the username and password distributed by Tersus, the end-user (NtripClient) in the region can only get the differential correction data using corresponding user name and password with the GeoBee base station, and the regional agent can not realize the configuration of the end-user's duration, limit days, available base station and other permissions. The new version of Caster software's Group User management function will make up for this weakness. The operation is as follows.

1)Log in to the specified web page and use the designated password to log in to the Group User management function.



The screenshot displays the TERSUS GNSS login interface. It features two distinct login sections. The upper section is a standard login form with input fields for 'USER' and 'PASSWORD', and a 'Query' button. The lower section is titled 'Group User' and contains input fields for 'Group User' and 'Group Password', along with a 'Login/Register' button. A prominent red arrow points to the 'Group Password' input field, indicating the required field for accessing the group user management function.

Figure 4.5 login interface for group user

2)After logging into Group User, enter the Group User interface, Group means the area where the regional agent is located. The next step is to pull the GeoBee base stations in the area into Group, by entering the user name and password of the GeoBee base stations distributed by Tersus and clicking Add.

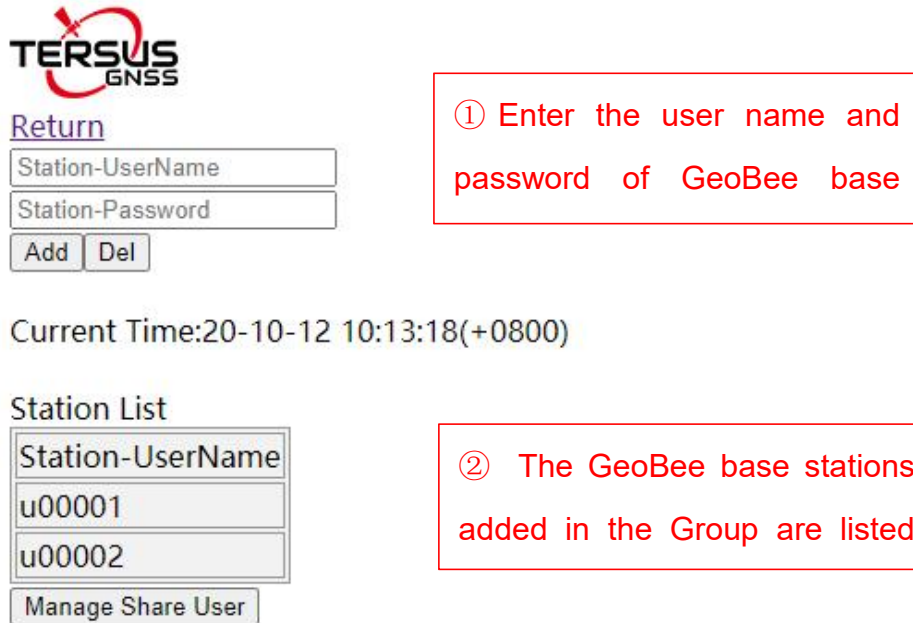

TERSUS GNSS

[Return](#)

Station-UserName

Station-Password

Add Del

Current Time:20-10-12 10:13:18(+0800)

Station List

Station-UserName
u00001
u00002

Manage Share User

① Enter the user name and password of GeoBee base

② The GeoBee base stations added in the Group are listed

Figure 4.5 base station list

If you want to remove a GeoBee base station that has been added to the Group, you need to enter the corresponding username and password and click the Del button. We need to make sure that the username and password are correct to prevent the base station from being accidentally removed.

3) Start to configure the client end-users in the regional group. Click the Manage Share User button, and enter the ShareUser configuration interface.

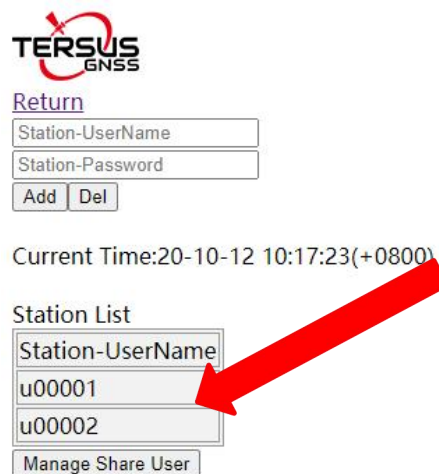

TERSUS GNSS

[Return](#)

Station-UserName

Station-Password

Add Del

Current Time:20-10-12 10:17:23(+0800)

Station List

Station-UserName
u00001
u00002

Manage Share User

Figure 4.6 manage share user

4)The regional agent inputs the username, password, expired date, limit days and limit numbers of the Client end-user to be configured. Please try to set a complex username and password according to the recommended rules to avoid the cases that different regional agents set the same username and password to cause end-users to connect to different regional base stations. The password is recommended to set a string consisting of letters or numbers.

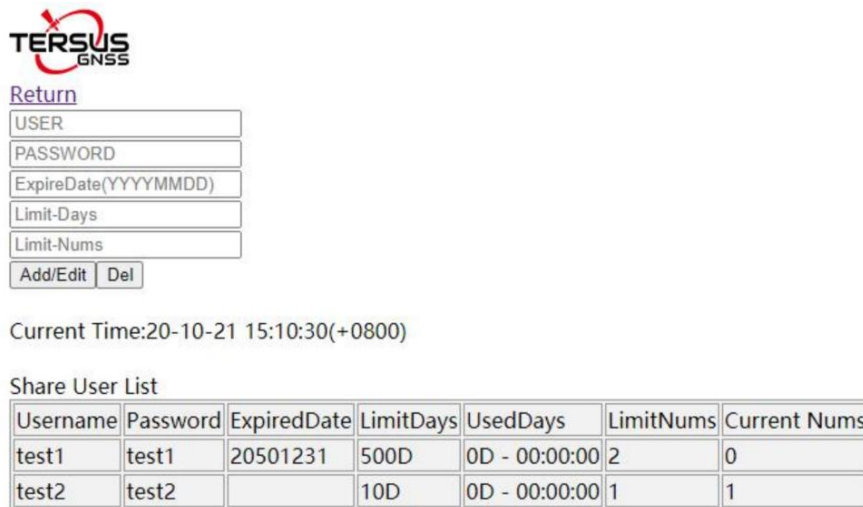

TERSUS GNSS

[Return](#)

USER

PASSWORD

ExpireDate(YYYYMMDD)

Limit-Days

Limit-Nums

Add/Edit Del

Current Time:20-10-21 15:10:30(+0800)

Share User List

Username	Password	ExpiredDate	LimitDays	UsedDays	LimitNums	Current Nums
test1	test1	20501231	500D	0D - 00:00:00	2	0
test2	test2		10D	0D - 00:00:00	1	1

Figure 4.7 the share user list

After setting the expired date of an end-user, once the end-user expires, the end-user will not be able to connect to Caster software to get the differential data. If not setting expired date, the Caster system will have no limit for the user's expired date.

After setting the limit days of end-user, the used days of end-user will be refreshed every time the end-user disconnects. When the used days reaches the limit days, the end-user will not be able to connect to Caster software to get the differential data. If more than one NtripClient uses the same user name and password to get the differential data at the same time, the used days of this user will be accumulated. If the limit days is not set, the Caster system will have no limit for the user's limit days.

After setting the limit number of concurrent online users, when every end-user

connects to the Caster system with this username and password, the current connection number will increase by 1. When the current number of connection reaches the limit number of concurrent online user allowed, the system will not be able to connect using this username and password. If the limit number of concurrent online users is not set, the Caster system will have no limit for the concurrent online user using this username and password.

It should be noted that after this update of Caster software, Client end-users are still allowed to use the username and password of GeoBee base station to connect and get differential data, and the username and password has no limitation of expiration date, allowable days or concurrently online users. In other words, if the regional agent does not use the new Group User management function, the end-users in the region can keep the previous login method unchanged.

4.5 Nearest Base Station Function

This version of Caster software adds the Nearest Base Station function which will automatically select the nearest base station among all the base stations that is allowed to connect to according to the GGA uploaded by the NtripClient end-user and establish the connection.

The Nearest Base Station operation is very simple, NtripClient end-user can select NearBy mount point when obtaining the Mountpoint. The distance calculation and selection of Nearest Base Station will be done inside Caster software.

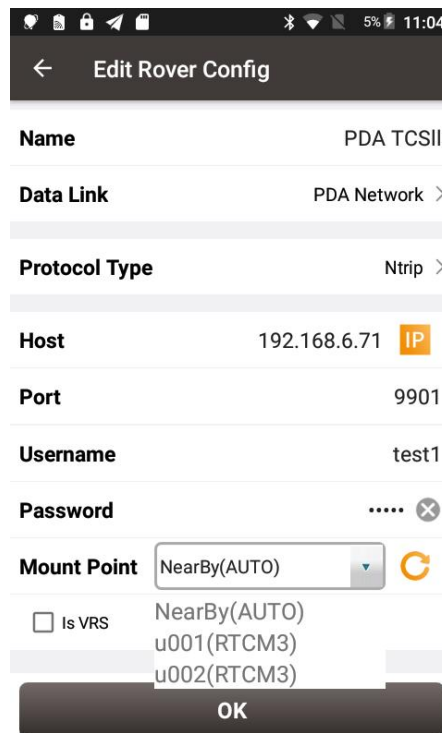

Figure 4.8 select nearby mount point

5. Lightning-Proof Design

The regional surface displacement monitoring system of the ground disaster monitoring uses lightning rods for direct lightning protection, single power supply arrester and communication cable arrester for inductive lightning protection.

5.1 Direct lightning protection

As the specific lightning protection method required, the distance between the lightning rod and the protected object must be not less than 3m. The height of lightning rod is determined in accordance with the 'Rolling Ball Rule' and can be roughly calculated.

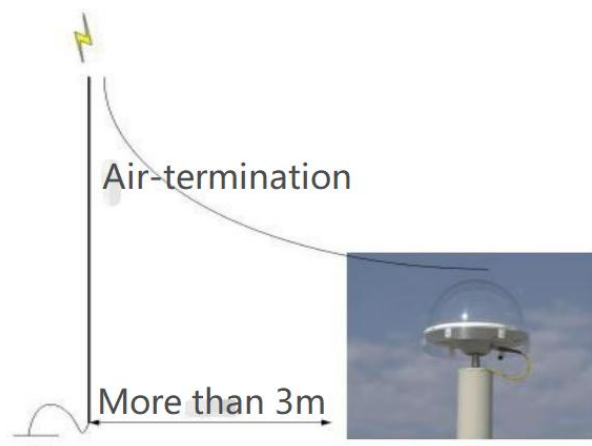

Figure 5.1 Schematic diagram of direct lightning prevention

ZGZ-200-2.1 type is selected as the lightning rod:



Figure 5.2 Lightning rod

Technical Parameters

- 1) Lightning current capacity(KA): 200;
- 2) Resistance(Ω): ≤ 1 ;
- 3) Height(m): 2.1;
- 4) Weight(kg): 4.8;
- 5) Maximum wind resistance(m/s): 40;
- 6) Installation size(mm): $\phi 70 \pm 0.26$.

5.2 Inductive lightning protection

5.2.1 Power lightning protection

Metal cabinet is used to shield inductive lightning, and the power unit is additionally assisted with lightning protection socket and single power supply arrester.

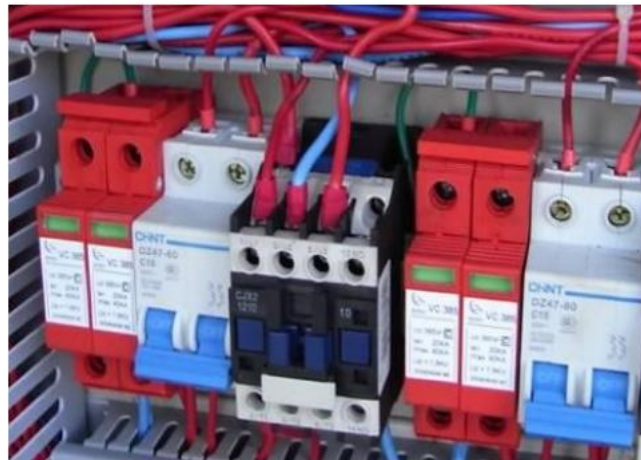

Figure 5.3 Single power lightning arrester

5.2.2 Lightning protection for communication cables

Install lightning protection devices at both ends of the communication cable. One end is close to the sensor to avoid current damage to the sensor due to the inductive lightning. And the other device is as close as possible to the data processing equipment.

The grounding terminal of the arrester is connected to the lightning protection net, with anti-rust paint on the connection to ensure conductivity, and the grounding resistance is less than 4Ω .

The lightning arrester has certain insertion loss, which has an impact on the strength of the data signal. So as to be necessary to equip the signal amplifier and other related equipment according to the actual situation.



Figure 5.4 The lightning arrester for communication cable

5.2.3 Grounding net

For the construction of grounding net, four $50 \times 50 \times 5$ mm hot dip galvanized angle steels are used as vertical poles $L=2.5$ m, which are inter connected by 40×4 mm hot dip galvanized flat steels, and the buried depth of the ground pole is more than 0.7 meters. The base of the lightning rod is $500 \times 500 \times 60$ mm reinforced concrete, which is connected with ground net by two 40×4 mm hot dip galvanized flat steels(the connection must be welded). The ground resistance is less than 10Ω .

6. Terminology

APN	Access Point Name
BDS	BeiDou Navigation Satellite System
DC	Direct Current
eMMC	Embedded Multi Media Card
EXIF	Exchangeable Image File Format
GLONASS	GLObal NAVigation Satellite System
GNSS	Global Navigation Satellite System
GPS	Global Positioning System
MSL	Mean Sea Level
PC	Personal Computer
PPK	Post-Processing Kinematic
PPS	Pulse Per Second
RINEX	Receiver Independent Exchange format
RMS	Root Mean Squares
RTK	Real-Time Kinematic
RTCM	Radio Technical Commission for Maritime Services
UAV	Unmanned Aerial Vehicle, drone
USB	Universal Serial BUS

Proprietary Notice

All Information in this document is subject to change without notice and does not reflect the commitment on Tersus GNSS Inc. No part of this manual may be reproduced or transmitted by all means without authorization of Tersus GNSS Inc. The software described in this document must be used in terms of the agreement. Any modification without permission from Tersus GNSS Inc. is not allowed.